



**CLOSED**

WILD CHERRY  
CXT-6031-7054  
SHOWN

4"  
102mm

17 3/8"  
441mm

**OPEN**



37 1/4"  
946mm

28 1/8"  
714mm

23 3/8"  
594mm

**STANDARD PART NUMBERS AND AVAILABLE COLORS\*\***

#60 FINISH STANDARD

FROSTY WHITE CXT-6031-1573	FUSION MAPLE CXT-6031-7909	PORTICO TEAK CXT-6031-8210	RUSSET ALONA CXT-6031-Y0291	WILD CHERRY CXT-6031-7054	BRIGHTON WALNUT CXT-6031-7922	OTHER COLORS CALL PROXIMITY CXT-6031-9999
----------------------------------	----------------------------------	----------------------------------	-----------------------------------	---------------------------------	-------------------------------------	---

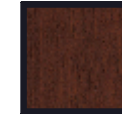
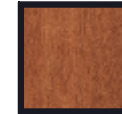
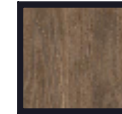
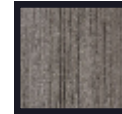
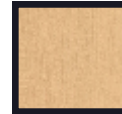

CXT283704B2NNNNND

**SPECIFICATIONS**

\*ASSUMES VESA HOLE PATTERN IS CENTERED ON MONITOR

EQUIPMENT	MAX SIZE DIMENSIONS
CPU	15"W x 10 1/2"H x 2 3/4"D
*MONITOR	23"W x 13"H x 2 3/4"D
KEYBOARD/MOUSE AREA	22"W x 20"D

ALL DIMENSIONS ARE IN INCHES UNLESS NOTED OTHERWISE. DESIGN SUBJECT TO CHANGE WITH EQUIPMENT SPECIFICATIONS. ALL INFORMATION ON THIS DRAWING IS PROPRIETARY AND MAY NOT BE USED WITHOUT PERMISSION FROM PROXIMITY SYSTEMS, INC. © 2020.

**OPTIONAL ACCESSORIES/PART NO. (NOT INCLUDED)**

1.	SLOPED CABINET TOP: AC-CTOP-4-XXXX
2.	N/A
3.	N/A

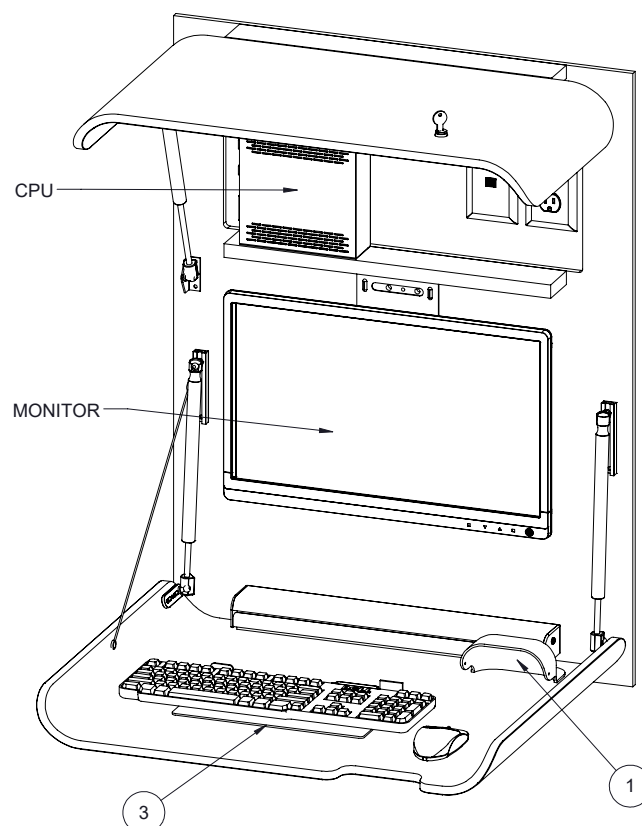
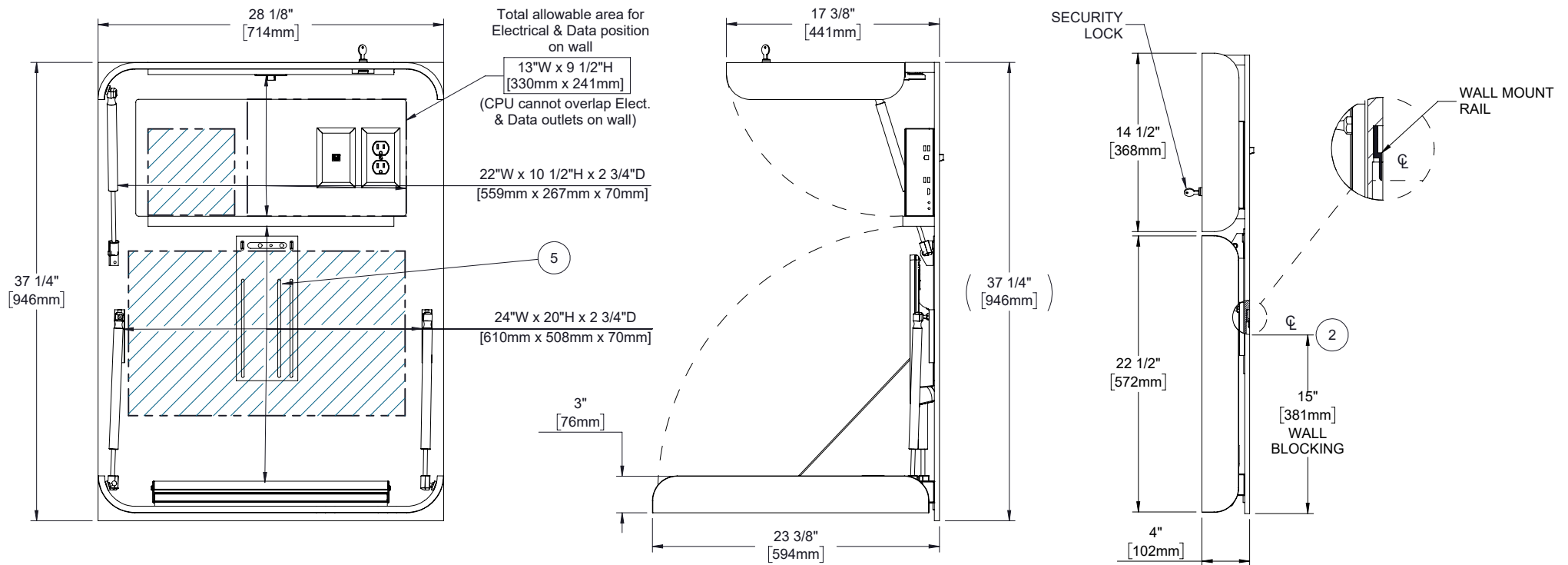

COMPONENTS INCLUDED	
ITEM NO.	COMPONENTS
1	MOUSE CATCHER
2	WALL MOUNT RAIL SYSTEM
3	KEYBOARD TRAY
4	N/A
5	MONITOR BRACKET MOUNT

CXT283704B2NNNNND



ALL DIMENSIONS ARE IN INCHES UNLESS NOTED OTHERWISE. DESIGN SUBJECT TO CHANGE WITH EQUIPMENT SPECIFICATIONS. ALL INFORMATION ON THIS DRAWING IS PROPRIETARY AND MAY NOT BE USED WITHOUT PERMISSION FROM PROXIMITY SYSTEMS, INC. © 2020.